



RoboCupJunior Rescue Line – Rules 2016

RoboCupJunior Rescue - Technical Committee 2016

Fredrik Löfgren (Sweden) CHAIR, fredrik@eaproduktion.se

Roberto Bonilla (Mexico), rbonilla@mytech.zone

Naomi Chikuma (Japan), mymama_8888@yahoo.co.jp

Kai Hannemann (Germany), kai.hannemann@gmail.com

Phil Wade (Australia), phil@ThreatVectorX.com

These are the official rules for RoboCupJunior 2016. They are released by the RoboCupJunior Rescue Technical Committee. The **English** rules have priority over any translations. Changes from the 2015 rules are highlighted in red.

Scenario

The land is simply too dangerous for humans to reach the victim! Your team has been given the most difficult tasks. It must be able to carry out the rescue mission in fully autonomous mode with no human assistance. The robot must be strong and smart enough to navigate through a treacherous terrain with hills, uneven lands and rubbles without getting stuck. When the robot finally finds the victim, it has to gently and carefully transport the victim to the safe evacuation point where humans can take over.

Time and technical skills are the essential! Come and prepare to be the most successful Rescue Response Team.

Summary

The robot should follow the line while overcoming different problems:

- 15 points for each tile with intersection(s)
- 10 points for each obstacle
- 10 points for reaching the line after a gap in the line
- 5 points for each tile with speed bump(s)

At the end of the line it will be a rectangular room with walls, where the robot should transport as many balls as possible to an evacuation point in one of the corners of the room. The team will earn 40 points for each ball.

If the robot gets stuck somewhere in the field it can be restarted at the last visited checkpoint. The robot will also earn points when it reaches new checkpoints.

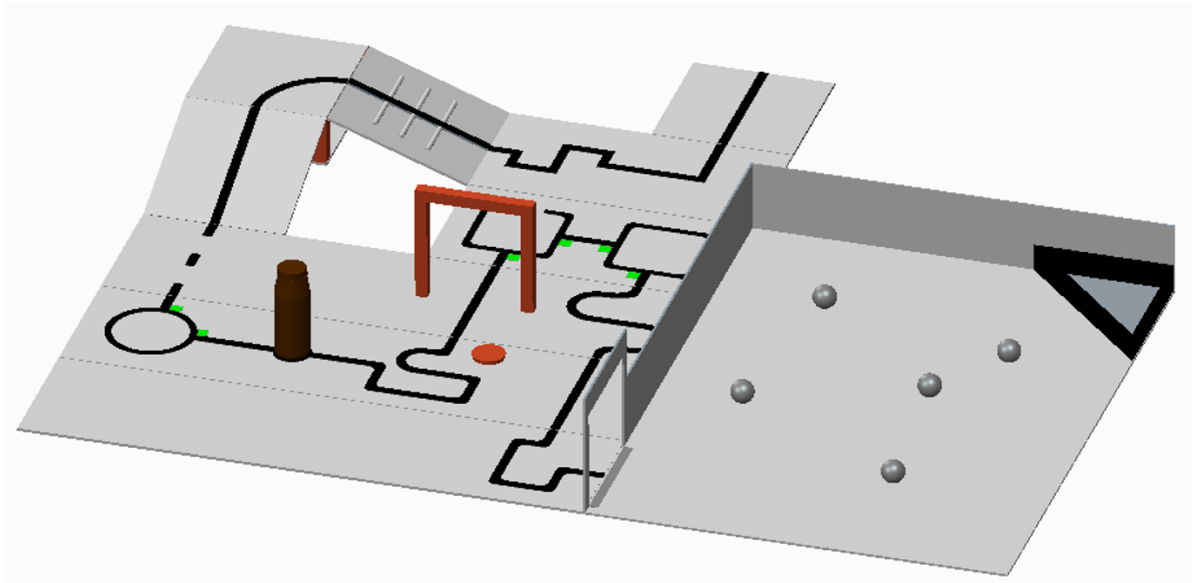

Contents	
RoboCupJunior Rescue Line – Rules 2016	1
Scenario	1
Summary	1
1. Arena	4
1.1 Description	4
1.2 Floor	4
1.3 Line	4
1.4 Debris, Speed Bumps and Obstacles	5
1.5 Intersections	5
1.6 Doorway	6
1.7 Evacuation Zone	6
1.8 Victims	6
1.9 Environmental Conditions	6
2. Robots	7
2.1 Control	7
2.2 Construction	7
2.3 Team	7
2.4 Inspection	8
2.5 Violations	8
3. Play	9
3.1 Pre-round Practice	9
3.2 Game Zone	9



3.3 Start of Play	9
3.4 Game Play	10
3.5 Scoring.....	10
3.6 Lack of progress:.....	11
3.7 Victim Placement.....	12
3.8 Evacuation Point Placement	12
3.9 End of Play	12
4. Open Technical Evaluation	13
4.1 Description.....	13
4.2 Evaluation Aspects	13
4.3 Awards	13
4.4 Sharing	14
5. Conflict Resolution	14
5.1 Referee and Referee Assistant.....	14
5.2 Rule Clarification	14
5.3 Special Circumstances.....	14
6. Code of Conduct	15
6.1 Spirit.....	15
6.2 Fair Play.....	15
6.3 Behavior	15
6.4 Mentors	15
6.5 Ethics and Integrity	16
6.6 Sharing	16

1. Arena

1.1 Description

1.1.1 The arena is modular by tiles, which can be used to make an endless number of different courses for the robots to traverse and also provides with the ability to add new tiles in the future.

1.1.2 The field will consist of 300 mm x 300 mm tiles, with different patterns. The final selection of tiles and their arrangement will not be revealed until the day of the competition. Competition tiles may be mounted on a hard backing material of any thickness.

1.1.3 There will be a minimum of 8 tiles in a competition field.

1.1.4 There are different tile designs (examples can be found under rule “1.3 Line”).

1.1.5 Tiles on different levels are connected with a ramp. A ramp does not exceed an incline of 25 degrees from the horizontal surface.

1.2 Floor

1.2.1 The floor has a white or close to white tone. The floor may be either smooth or textured (like linoleum or carpet), and may have steps of up to 3 mm height at joins between tiles. **Due to the nature of the tiles, there may be a step and/or gap in the construction of the arena. These are not intentional and will be minimized as much as possible by the organizers.**

1.2.2 Competitors need to be aware that in some competitions, tiles may be mounted on thick backing or raised off the ground, which may make it difficult to get back on a tile should the robot come off. No provision will be made to assist robots that drive off a tile, **for** getting back on the tile.

1.2.3 Tiles will be used as ramps to allow the robots to “climb” up to and down from the elevated tile.

1.2.4 Robots, therefore, must be designed so that they can navigate along any tile that may be placed **under another tile. The minimum free height will be 25 cm.**

1.3 Line

1.3.1 The black line, 1-2 cm wide, may be made with standard electrical insulating tape or printed onto paper or other materials. The black line forms a path on the floor. (The grid lines indicated in the drawings are for reference only and competitors can expect tiles to be duplicated, different and/ or omitted.)

1.3.2 Straight sections of the black line may have gaps with at least 5 cm of straight line before each gap. The gap is 20 cm at most.

1.3.3 The arrangement of the tiles **and paths** may vary between rounds.

1.3.4. The line will never be closer than 10cm to any edge, so the robot will never fall of the arena.

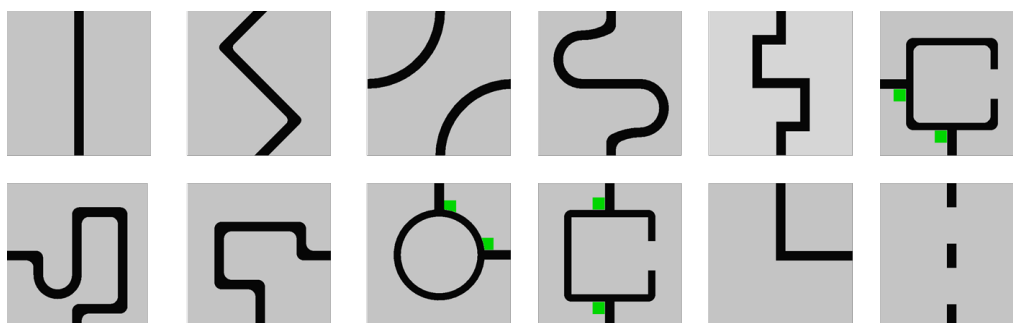

1.4 Debris, Speed Bumps and Obstacles

- 1.4.1 Speed bumps have a maximum height of 1 cm. They are white and fixed on the floor. They may be angled.
- 1.4.2 Debris are maximum height of 3mm, and will not be fixed on the floor. They are small materials such as toothpicks or small wooden dowel, etc.
- 1.4.3 Debris may be spread towards or adjacent to walls.
- 1.4.4 Obstacles may consist of bricks, blocks, weights and other large, heavy items. **Obstacles will be at least 15cm high.**
- 1.4.5 An obstacle does not occupy more than one line.
- 1.4.6 A Robot is expected to navigate around obstacles. **The robot may also push the obstacle but note that obstacles may be very heavy or even fixed to the floor.** Obstacles that are moved in any way will remain where they are moved to, even if it ends up prohibiting your robot from proceeding.

1.5 Intersections

- 1.5.1 Intersections can be placed anywhere except in the evacuation zone.
- 1.5.2 Intersections markers are green and 25 mm x 25 mm in dimension and indicate the path to follow. If no green marks are placed at an intersection, it means continue straight.
- 1.5.3 The intersections are always perpendicular, but may have 3 or 4 branches.
- 1.5.4. **The intersection mark to follow is placed just before the intersection. See image below for possible cases.**

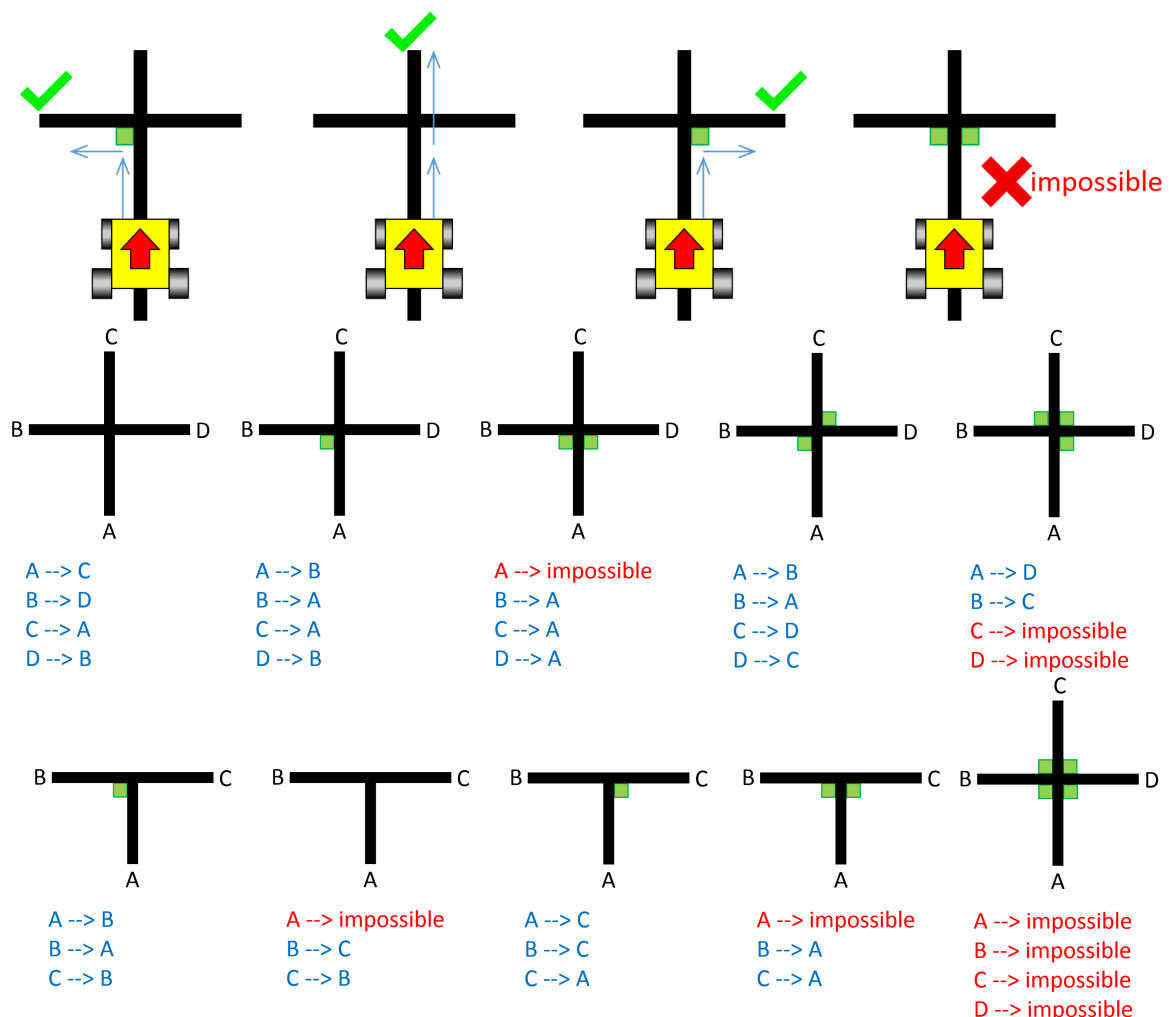

1.6 Doorway

1.6.1 The arena may have doorways to keep backward compatibility with the old style Plexiglas arenas. The doorway will be 25 cm wide and 25 cm high.

1.6.2 The doorway will be placed perpendicular to the line.

1.7 Evacuation Zone

1.7.1 The black line ends at the entrance of the evacuation zone. Inside the evacuation zone robots are required to utilize some form of search strategy to locate the victims.

1.7.2 The Evacuation Zone is approximately 120 cm by 90 cm with walls in the 4 sides that are at least 10 cm high.

1.7.3 At the entrance to the evacuation zone, there is a 25 mm x 250 mm strip of reflective silver tape on the floor.

1.7.4 For the Primary competition, the Evacuation Point tile is a right angled triangle with sides of 30 cm x 30 cm, and it is painted in black with a bump of 5 mm.

1.7.5 For the Secondary competition, the Evacuation Point tile is a right angled triangle, sides of 30 cm x 30 cm, elevated by 6 cm, and it is painted in black and hollow.

1.7.6 The evacuation zone does not have an exit door.

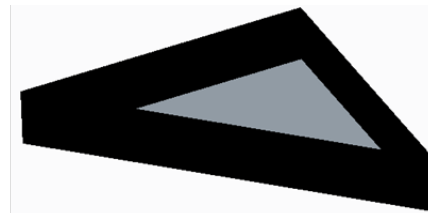
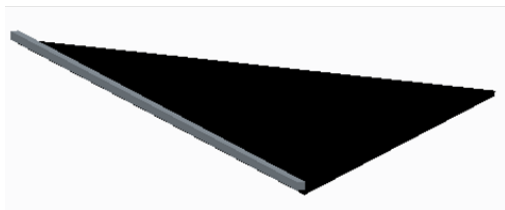

1.8 Victims

1.8.1 Victims may be located anywhere on the floor of the evacuation zone.

1.8.2 The victims take the form of a 5 cm diameter ball. Teams need to be prepared for minor variations.

1.8.3 The victim represents a living person and will be electrically conductive. Its surface is silver and reflects light.

1.9 Environmental Conditions

1.9.1 Teams should expect the environmental conditions at a tournament to be different from the conditions at their home practice field.

1.9.2 Teams must come prepared to adjust their robots to the conditions at the venue.

1.9.3 Lighting and magnetic conditions may vary along the course in the rescue arena.

1.9.4 The arena may be affected by magnetic fields (e.g. generated by under floor wiring and metallic objects).

1.9.5 Teams should prepare their robots to handle unexpected lightning interference. While the organizers and referees will try their best to minimize external lighting interference, it is not possible for them to foresee all unexpected ones such as camera flash from spectators.

1.9.6. All measurements in the rules have a tolerance of 5%.



2. Robots

2.1 Control

2.1.1 Robots must be controlled autonomously. The use of a remote control or manual control, or passing information (by sensors, cables, **wirelessly**, etc.) to the robot is not allowed.

2.1.2 Robots must be started manually by the team captain.

2.1.3 Pre-mapped type of dead reckoning (movements predefined based on known locations **before game play**) is prohibited.

2.1.4 Robots must not damage any part of the arena in any way.

2.2 Construction

2.2.1 Any robot kit or building blocks, either available on the market or built from raw hardware, may be used, as long as the design and construction of the robot are primarily and substantially the original work of the students (see section 2.5 below).

2.2.2 Any commercially produced robot kits or sensor components that are specifically marketed to complete any single major task of RoboCupJunior Rescue will be disqualified. For example, pre-programmed sensors with special features for line-following or obstacle tracing are not allowed. If there is any doubt, teams should consult the Technical Committee (TC).

2.2.3 For the safety of participants and spectators, **only lasers of class 1 and 2** are allowed. **This will be checked during inspection.**

2.2.4 Bluetooth Class 2, 3 and ZigBee communications are the only wireless communication types allowed in RoboCupJunior. Robots that have other types of wireless communications on board will need to be either removed or disabled for possible interference with other leagues competing in RoboCup. If the robot has equipment for other forms of wireless communication, **the team** must prove that they have disabled them. Robots that do not comply may face immediate disqualification from the tournament.

2.2.5 Robot must be able to pass through the doorway without moving it from its original position.

2.3 Team

2.3.1 Each team must have only one robot in the field. (This rule can be modified in a Super Team Competition such that robots **from different teams** are deployed together and have to cooperate in completing given tasks.)

2.3.2 Each team must have a minimum of 2 members.

2.3.3 Students will participate in ONLY ONE (1) of the three (3) divisions: Primary Rescue Line, Secondary Rescue Line or Rescue Maze.

2.3.4 Eligibility for the **international event** is:

- Rescue Line **Primary**: Open to students **between 11 and 14** years old. Age is calculated as of July 1 for the international RCJ event each year.
- Rescue Line **Secondary**: Open to students **from 11** up to and including 19 years of age. Team members may compete in Secondary Rescue at most, twice (2 international events). After competing twice they must move to Rescue Maze.

Rescue Maze: Open to students **from age of 11** up to and including 19 years of age.



2.3.5 The number of team members per a team is limited to **6 members maximum** but team should choose their team size in a way that the learning experience of each member is maximized. Mentors/parents are not allowed to be with the students during the competition. The students will have to self-govern themselves (without mentor's supervision) during the long stretch of hours at the competition.

2.3.6 Every team member can be registered in only one team, and every team can compete in only one RoboCupJunior league and division.

2.4 Inspection

2.4.1 The robots will be examined by a panel of referees before the start of the tournament and at other times during the competition to ensure that they meet the constraints described.

2.4.2 It is highly unlikely that a team will be able to legally use a robot identical to another team's robot from previous **or the current** year, or use a robot that is identical to another team's robot.

2.4.3 It is the responsibility of teams to have their robots re-inspected, if their robots are modified at any time during the tournament.

2.4.4 Students will be asked to explain the operation of their robots, in order to verify that construction and programming of the robot is their own work.

2.4.5 Students will be asked about their preparation efforts, and may be requested to answer surveys and participate in video-taped interviews for research purposes.

2.4.6 All teams must fill a web form that will be provided once the team is officially registered, and should be submitted at least one week prior to the competition. The purpose of this document is to allow judges to be better prepared for the interviews. For sample documentation, please refer to the "Description of Materials Template" at the official RCJ website under Rescue rules. Information about how to submit your document will be announced prior to the competition to the teams.

2.4.7 All teams have to submit their **source** code prior to the competition. The **source** code is never shared with other teams without the team's permission.

2.5 Violations

2.5.1 Any violations of the inspection rules will prevent the offending robot from competing until modifications are applied.

2.5.2 However, modifications must be made within the time schedule of the tournament and teams must not delay tournament play while making modifications.

2.5.3 If a robot fails to meet all specifications (even with modification), it will be disqualified from that round (but not from the tournament).

2.5.4 No mentor assistance during the competition is allowed. See 6. Code of Conduct.



3. Play

3.1 Pre-round Practice

3.1.1 Where possible, competitors will have access to practice arenas for calibration, testing and tuning throughout the competition.

3.1.2 Whenever there are dedicated independent arenas for competition and practice, it is at the organizers' discretion if testing is allowed on the competition arena.

3.2 Game Zone

3.2.1 An area around the game fields will be designated as the "game zone".

3.2.2 Teams should designate one of its own team members as the captain, and s/he will be allowed to move the robot, based on the stated rules and/or as directed by a referee. Only the captain is allowed to enter the game zone and interact with the robot during a scoring run.

3.2.3 The captain can move the robot only when s/he is told to do so by a referee.

3.2.4 Other team members (and any spectators) within the vicinity of the rescue arena have to stand at least 150 cm away from the arena while their robot is active, unless otherwise directed by a referee.

3.2.5 No one is allowed to touch the arenas intentionally during a scoring run.

3.3 Start of Play

3.3.1 A run begins at the scheduled starting time whether or not the team is present/ready. Start times will be posted prominently around the venue.

3.3.2. The **checkpoint marker** is a marker that indicates for humans which tiles are checkpoints. It can be 5mm to 12mm thick and up to 70mm in diameter.

3.3.3 Before the game starts the team captain will decide which tiles should be checkpoints and place the markers on these tiles. The number of possible checkpoints will depend on the length of the course.

3.3.4 It is not allowed to place several checkpoint markers on the same tile, nor place them on a tile with scoring elements. Once the scoring run has begun (see 3.3.10), the markers cannot be changed. Note: If a robot moves a marker, it is still the original tile that is the checkpoint. The marker is only there for humans to remember where the checkpoints are located.

3.3.5 The start tile is implicitly a checkpoint, where the robot can restart. The team doesn't need to use one of their checkpoint markers for the start tile.

3.3.6 Once the scoring run has begun, the robot playing is not permitted to leave the competition area.

3.3.7 A robot will be given a maximum time of 8 minutes to both calibrate its sensors and complete the course. The time for each run will be kept by the referee.

3.3.8 Calibration is defined as taking sensor readings and modifying the robot's programming to accommodate such sensor readings. Any and all pre-mapping activities will result in immediate disqualification of the robot for the round.

3.3.9 Teams may calibrate their robot in as many locations as desired on the arena, but the clock will continue to count down. Robots are not permitted to move using its own power while calibrating.

3.3.10 Once a team is ready to perform a scoring run, they must notify the referee. To begin a scoring run, the robot is placed on the starting tile of the course as indicated by the referee. Once a scoring run has begun, no more calibration is permitted, this includes changing of code/code selection.

3.3.11 Once a robot begins its scoring run, the referee will roll a standard 6 sided dice to determine in which corner the Evacuation Point will be located.

3.4 Game Play

- 3.4.1 Robots are to start behind the join between the start tile and the next course tile towards the evacuation zone. Correct placement will be checked by the Referee.
- 3.4.2 Modifying the robot during a run is prohibited; which includes remounting parts that have fallen off.
- 3.4.3 All parts that the robot is losing intentionally or unintentionally will be left in the arena until the run is over. Neither the team nor a judge is allowed to remove parts from the arena during a run.
- 3.4.4 Teams are not allowed to give their robot any advance information about the field. A robot is supposed to recognize the field by itself.
- 3.4.5 The robot must follow the line completely to enter the evacuation zone.

3.5 Scoring

- 3.5.1 A robot is awarded points for successfully negotiating each hazard (gaps in the line, speed bumps, intersections and obstacles).
- 3.5.2 Successfully negotiating is defined as completely following the line, negotiating all line gaps, intersections, speed bumps, obstacles, and going through a doorway without human interaction.
- 3.5.3 Failed attempts at negotiating elements of the arena are defined as “Lack of Progress” (see 3.6).
- 3.5.4 **When a robot reaches a checkpoint it will earn points for each tile it has passed since the last visited checkpoint. The points depend on how many attempts the robot has done to reach the next checkpoint:**
 - 1st attempt = 3 points/tile
 - 2nd attempt = 2 points/tile
 - 3rd attempt = 1 points/tile
 - Beyond 3rd attempt = 0 points/tile

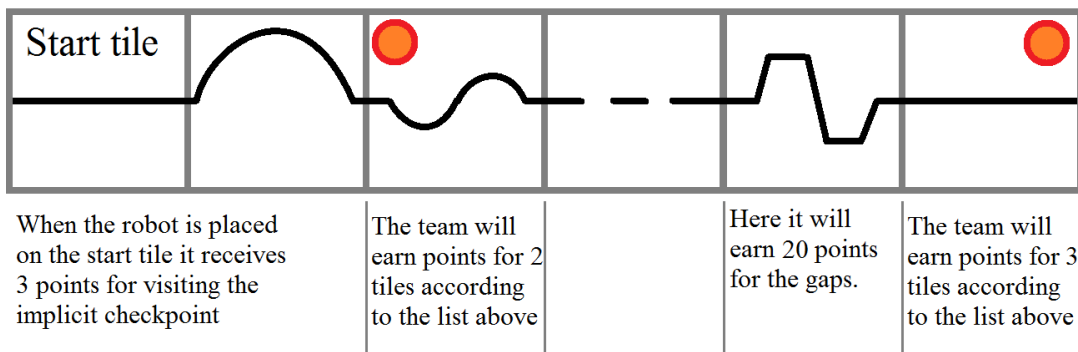

- 3.5.5 If intersections are used, the path may go to the opposite direction through the course (going back to the path that a robot already took).
- 3.5.6 Points available for successfully negotiating each gap in the black line. 10 points per gap.
- 3.5.7 Points available for successfully avoiding each obstacle blocking the black line. 10 points per obstacle. **The team will also get points if the robot pushed the obstacle away and continues to follow the line, but the obstacle may be fixed to the floor.**
- 3.5.8 A robot is considered to have successfully negotiated an obstacle when it moved through the tile where an obstacle was placed.
- 3.5.9 Points available for successfully completing a tile that has speed bumps. 5 points per speed bump tile.
- 3.5.10 Points available for successfully negotiating an intersection tile. 15 points per direction through intersection tile. **Note that this means two intersections at the same tile only counts as 15 points for each direction. See also rule 3.6.1.**

3.5.11 Each gap, obstacle, speed bump and intersection tile can only be scored once per direction through the course, not each attempt through the course.

3.5.12 Successful victim rescue: Robots are awarded points for successfully rescuing victims. A successful victim rescue occurs when the victim is moved to the evacuation point (it needs to be completely inside of the evacuation point, and no part of the robot be in contact with the victim). 40 points per a successful victim rescue.

3.5.13 Ties in scoring will be resolved on the basis of the time taken by each robot (or team of robots) to complete the course (this includes calibration time).

3.6 Lack of progress

3.6.1 A lack of progress occurs when:

- The robot loses the black line without regaining it by the next tile in the sequence (see figures below).
- **A robot does not follow the indicated direction at an intersection.**
- **A robot is escaping the evacuation room. When the robot has entered the evacuation room it is not allowed to go back to the line again**

3.6.2 The team captain can also call for a Lack of Progress at any time s/he wants (for example if the robot is in danger **or got stuck**).

3.6.3 If a Lack of Progress happens, the robot must be positioned at the previous **checkpoint** facing the evacuation zone, and checked by the referee.

3.6.4 Only the team captain is allowed to restart the robot without changing programs and/or modifying the robot.



3.6.5 There is no limit to the number of restarts within a game.

3.6.6 A robot is allowed to proceed to the following **checkpoint**, if the robot fails to reach it after the third attempt.

3.6.7 The team captain may also choose to make further attempts at the course to earn the additional points available for overcoming obstacles, gaps in the line, intersections and speed bump points that have not already been earned before reaching the **checkpoint**.

3.6.8 If a lack of progress happens in the evacuation zone the victims will not be moved, any rescued victims will remain, as well as victims in the evacuation zone, even victims that escaped the evacuation zone will be left where they are. Victims that are hold by the robot will be released and thrown into the evacuation zone by the referee.

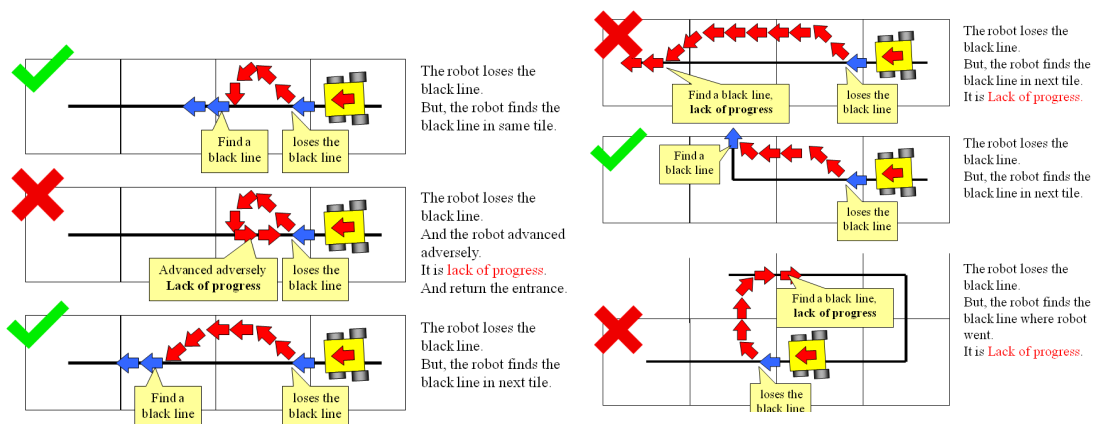

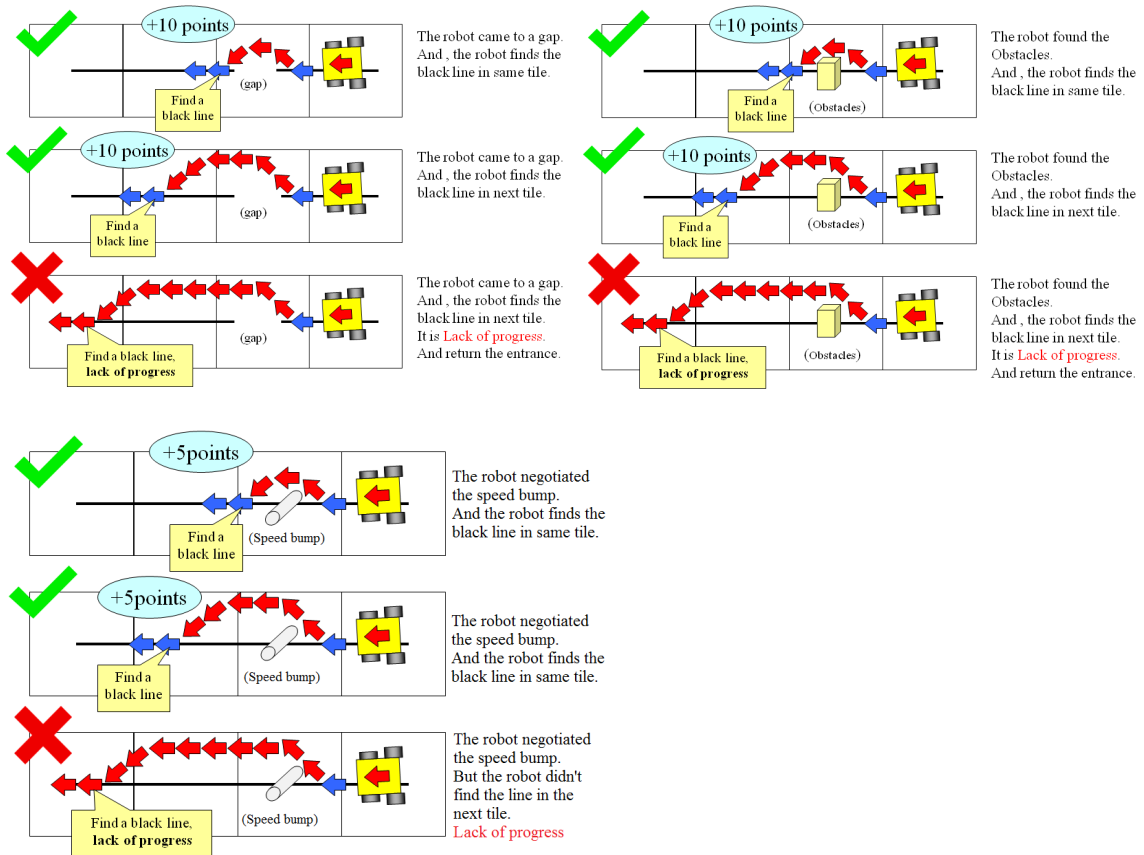

3.7 Victim Placement

3.7.1 The victims will be allocated in a random way on the Evacuation Zone. The number of victims will be decided by the Organizing Committee. The number of victims will be the same for each field (or arena) layout.

3.8 Evacuation Point Placement

3.8.1 The Evacuation Point will be placed in any of the non-entry corners in the evacuation zone.

3.8.2 After a Lack of Progress happened in any place, the referee may roll the dice once more and place the Evacuation Point at a new corner.

3.8.3 The RoboCupJunior Organizing Committee (OC) will try their best to secure the Evacuation Point down, but you should expect it to slight shift at times.

3.9 End of Play

3.9.1 A team may elect to stop the round early at any time. In this case, the team captain must indicate to the referee the team's desire to terminate. The team will be awarded all points achieved up to the call for end of round.

3.9.2 The round ends when the time expires, when the team captain calls the end of the round or when all the victims are successfully rescued.



4. Open Technical Evaluation

4.1 Description

4.1.1 Your technical innovation will be evaluated during a dedicated time frame. All teams need to prepare for an open display during this time frame.

4.1.2 Judges will go around interacting with teams. It will be set up as more like a casual conversation or "questions and answers" atmosphere.

4.1.3 The main objective of the Open Technical Evaluation is to emphasize the ingenuity of innovation. Being innovative may mean technical advance as compared to the existing knowledge, or an out-of-the-ordinary simple but clever solution to existing tasks.

4.2 Evaluation Aspects

4.2.1 A standardized rubric system is used focusing on:

- a) creativity
- b) cleverness
- c) simplicity
- d) functionality

4.2.2 "Your work" can include (but is not limited to) one of the following aspects:

- a) creation of your own sensor instead of a pre-built sensor
- b) creation of a "sensor module" which comprises of various electronics to provide a self-contained module to provide a certain special functionality
- c) creation of a mechanic module which is functional, but out of the ordinary
- d) creation of a new software algorithm to a solution

4.2.3 Teams must provide documents that explain their work. Each invention must be supported by concise but clear documentation. The documents must show concise inventive steps.

4.2.4 Documents must include one poster and one engineering journal (see the Engineering Journal Template on official RCJ website for more details). Teams are expected to be readily prepared to explain their work.

4.2.5 Engineering Journal should demonstrate your best practice in your development process.

4.2.6 The poster **should** include **name of team, country, league, robot description, robot capabilities, controller and programming language used, sensors included, method of construction, time used for developing, cost of materials and awards won by the team in its country**, etc.

4.2.7 Guidelines may be provided at the official RCJ website under Rescue rules (Engineering Journal Template).

4.3 Awards

4.3.1 Awards may be divided into several categories.

- a) Innovation:
 - Mechanical innovation
 - Electronic innovation
 - Algorithm innovation
- b) Robust Design:
 - Mechanical design
 - Electronic design
 - Algorithm design



c) Team work – demonstration of great collaborations within the team.

d) Best Practice (in development) – demonstration of the best development practice from brainstorming, designing, prototyping, development, test plan, quality assurance plan, etc.

4.3.2 Awards will be given in the form of a certification.

4.4 Sharing

4.4.1 Teams are encouraged to review other's posters and presentations.

4.4.2 The awarded teams are required to post their documents and presentation online when asked by the TC.

5. Conflict Resolution

5.1 Referee and Referee Assistant

5.1.1 All decisions during game play are made by the referee or the referee assistant who are in charge of the arena, persons and objects surrounding them.

5.1.2 During game play, the decisions made by the referee and/or the referee assistant are final.

5.1.3 At conclusion of game play, the referee will ask the captain to sign the score sheet. Captain should be given maximum 1 minute to review the score sheet and sign it. By signing it, the captain accepts the final score on behalf of the entire team; in case of further clarification, the team captain should write their comments in the score sheet and sign it.

5.2 Rule Clarification

5.2.1 If any rule clarification is needed, please contact the International RoboCupJunior Rescue Technical Committee.

5.2.2 If necessary even during a tournament, a rule clarification may be made by members of the RoboCupJunior Rescue Technical Committee and Organizing Committee.

5.3 Special Circumstances

5.3.1 If special circumstances, such as unforeseen problems or capabilities of a robot occur, rules may be modified by the RoboCupJunior Rescue Organizing Committee Chair in conjunction with available Technical Committee and Organizing Committee members, if necessary even during a tournament.

5.3.2 If any of the team captains/mentors do not show up to the team meetings to discuss the problems and the resulting rule modifications described at 5.3.1, it will be considered as an agreement.



6. Code of Conduct

6.1 Spirit

6.1.1 It is expected that all participants (students and mentors alike) will respect the aims and ideals of RoboCup Junior as set out in our mission statement.

6.1.2 The volunteers, referees and officials will act within the spirit of the event to ensure the competition is competitive, fair and most importantly fun.

6.1.3 *It is not whether you win or lose, but how much you learn that counts!*

6.2 Fair Play

6.2.1 Robots that cause deliberate or repeated damage to the arena will be disqualified.

6.2.2 Humans that cause deliberate interference with robots or damage to the arena will be disqualified.

6.2.3 It is expected that the aim of all teams is to participate fairly.

6.3 Behavior

6.3.1 Participants should be mindful of other people and their robots when moving around the tournament venue.

6.3.2 Participants are not allowed to enter setup areas of other leagues or other teams, unless explicitly invited to do so by team members.

6.3.3 Teams will be responsible for checking update information (schedules, meetings, announcements, etc.) during the event. Update information will be provided on notice boards in the venue and (if possible) on the local competition website and/or the RoboCup or RoboCupJunior websites.

6.3.4 Participants who misbehave may be asked to leave the building and risk being disqualified from the tournament.

6.3.5 These rules will be enforced at the discretion of the referees, officials, tournament organizers and local law enforcement authorities.

6.4 Mentors

6.4.1 Adults (mentors, teachers, parents, chaperons, translators and other adult team members) are not allowed in the student work area.

6.4.2 Sufficient seating will be supplied for mentors to remain in a supervisory capacity close to the student work area.

6.4.3 Mentors are not permitted to repair robots or be involved in programming of their team's robots.

6.4.4 Mentor interference with robots or referee decisions will result in a warning in the first instance. If this recurs, the team will risk being disqualified.

6.4.5 Robots have to be mainly students' own work. Any robot that appears to be identical to another robot may be prompted for re-inspection.



6.5 Ethics and Integrity

6.5.1 Fraud and misconduct are not condoned. Fraudulent acts may include the following:

- a) Mentors working on the software or hardware of students' robot(s) during the competition.
- b) "Higher league group" and/or more advanced group of students may provide advice, but should not do the work for "Lower league group". For example, a secondary group helped to fix its peer primary group's work, software or hardware prior to and/or during the competition. This may risk the secondary group to be disqualified as well. See "Code of Conduct, 6.4.3 & 6.4.5". This applies not just to mentors, but also to higher league (advanced) group of students as well.

6.5.2 RoboCupJunior reserves the right to revoke an award if fraudulent behavior can be proven after the awarding ceremony took place.

6.5.3 If it is clear that a mentor intentionally violates the code of conduct, and repeatedly modifies and works on the students' robot(s) during the competition, the mentor will be banned from future participation in RoboCupJunior competitions.

6.5.4 Teams that violate the code of conduct can be disqualified from the tournament. It is also possible to disqualify only a single team member from further participation in the tournament.

6.5.5 In less severe cases of violations of the code of conduct, a team will be given a warning. In severe or repeated cases of violations of the code of conduct, a team can be disqualified immediately without a warning.

6.6 Sharing

6.6.1 The spirit of world RoboCup competitions is that any technological and curricular developments should be shared with other participants after the tournament.

6.6.2 Any developments may be published on the RoboCupJunior website after the event.

6.6.3 Participants are strongly encouraged to ask questions to their fellow competitors to foster a culture of curiosity and exploration in the fields of science and technology.

6.6.4 This furthers the mission of RoboCupJunior as an educational initiative.